

# ARIO Series

## Slim Remote I/O

### ■ Features

- I/O supported based on industrial Ethernet / Fieldbus serial communication for Smart Factory
- Sequential multiple I/O distribution control via PLC, Industrial PC, etc.
- Coupler: Supports a total of 8 different communications  
EtherCAT, CC-Link, ProfiNet, ProfiBus, Ethernet/IP, DeviceNet, Modbus TCP compatible, Modbus RTU compatible
- Modules: Various Input / Output Modules, Power Modules  
- Remote ABUS/ I/O power, Digital input/output (4/8CH), Analog input/output (2/4CH), Temperature input (4CH)  
- Up to 64 modules can be extended (depending on communication)
- Hot-swap function  
: Maintenance and setting can be restored automatically by replacing terminal and body during operation
- Push-in connection method: Easy wire connection without tools helps reducing workload
- Expanded user convenience with DAQMaster, a device integration management program  
- Module setting, real time control and monitoring / diagnosis of input / output signal (except ARIO-C-PN/PB)  
- Product selection and placement through virtual mode, offering recommended sorting



**⚠ Please read "Safety Considerations" in the instruction manual before using.**



### ■ Models

#### ● Coupler

Model	ARIO-C-EC	ARIO-C-CL	ARIO-C-PN	ARIO-C-PB	ARIO-C-EI	ARIO-C-DN	ARIO-C-MT	ARIO-C-MR
Coupler type	EtherCAT	CC-Link	ProfiNet	ProfiBus	Ethernet/IP	DeviceNet	ModbusTCP compatible	ModbusRTU compatible

#### ● Digital Input/Output Module

Type	Digital input module				Digital output module						
Model	4CH	ARIO-S-DI04N	ARIO-S-DI04P	ARIO-S-DO04N	ARIO-S-DO04P	Model	2 CH	ARIO-S-AI02V1/2	ARIO-S-AI02C1/2	ARIO-S-AO02V1/2	ARIO-S-AO02C1/2
	8CH	ARIO-S-DI08N	ARIO-S-DI08P	ARIO-S-DO08N	ARIO-S-DO08P		4 CH	ARIO-S-AI04V1/2	ARIO-S-AI04C1/2	ARIO-S-AO04V1/2	ARIO-S-AO04C1/2
I/O common	NPN	PNP	NPN	PNP							

#### ● Analog Input/Output Module

Type	Analog input module				Analog output module						
Model	2 CH	ARIO-S-AI02V1/2	ARIO-S-AI02C1/2	ARIO-S-AO02V1/2	ARIO-S-AO02C1/2	Model	2 CH	ARIO-S-AI02V1/2	ARIO-S-AI02C1/2	ARIO-S-AO02V1/2	ARIO-S-AO02C1/2
	4 CH	ARIO-S-AI04V1/2	ARIO-S-AI04C1/2	ARIO-S-AO04V1/2	ARIO-S-AO04C1/2		4 CH	ARIO-S-AI04V1/2	ARIO-S-AI04C1/2	ARIO-S-AO04V1/2	ARIO-S-AO04C1/2
I/O method	Voltage input	Current input	Voltage output	Current output							

#### ● Power Module

Model	ARIO-P-B	ARIO-P-F1	ARIO-P-F2	ARIO-P-T1	ARIO-P-T2	
Power module	Slim Remote ABUS power	Slim Remote I/O power				
No. I/O supply power	24V 0V	— —	6 2	2 6	8 4	4 8

#### ● Temperature Input Module

Type	TC input module		RTD input module	
Model	4CH	ARIO-S-AI04TC	ARIO-S-AI04RTD	
Input method	Voltage input	Resistance input		

※ Coupler: You can order each the terminal and base.  
Module: You can order each the terminal, body, and base.

### ■ Comprehensive Device Management Program (DAQMaster)

- DAQMaster is comprehensive device management program. It is available for parameter setting, monitoring.
- Visit our website ([www.autonics.com](http://www.autonics.com)) to download user manual and comprehensive device management program.

< Computer specification for using software >

Item	Minimum requirements
System	IBM PC compatible computer with Intel Pentium III or above
Operating system	Microsoft Windows 98/NT/XP/Vista/7/8/10
Memory	256MB or more
Hard disk	More than 1GB of free hard disk space
VGA	1024×768 or higher resolution display
Others	RS-232 serial port (9-pin), USB port

< DAQMaster screen >

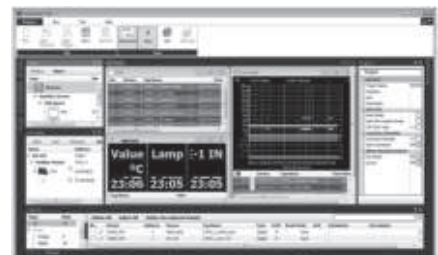

## Manuals

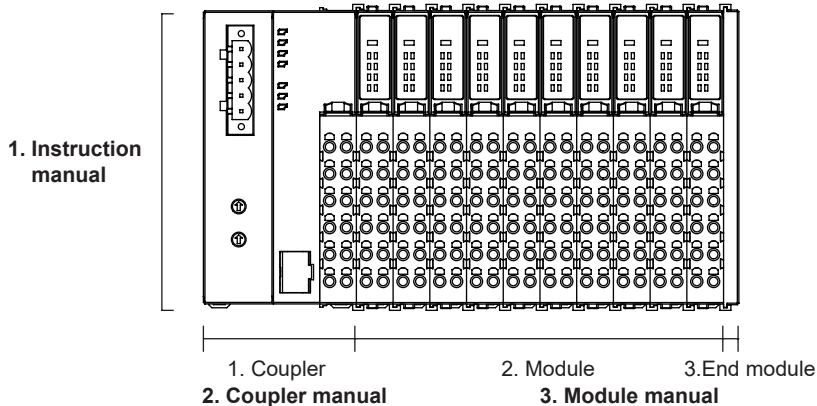

### 1. Instruction manual

It describes an overview of Remote I/O, definitions of terms, installation environment, routing/ removing method, wiring and troubleshooting.

### 2. Coupler manual

It describes the overview, specification, dimensions, memory map and troubleshooting of each communication.

### 3. Module manual

It describes the specification, dimensions, and connections of each module.

## Coupler

### Specifications

Model	ARIO-C-EC	ARIO-C-CL	ARIO-C-PN	ARIO-C-PB	ARIO-C-EI	ARIO-C-DN	ARIO-C-MT	ARIO-C-MR	
Coupler type	EtherCAT	CC-Link	ProfiNet	ProfiBus	Ethernet/IP	DeviceNet	ModbusTCP compatible	ModbusRTU compatible	
Power supply ※1	ABUS (external consump.)	24VDC≒, max. 400mA (max. 9.6W, coupler+module, max. 200mA/CH, 2CH/COM)							
	ABUS (internal supply)	5VDC≒, max. 960mA (max. 4.8W, module)							
	I/O	24VDC≒, max. 4,000mA (max. 96W, max. 2,000mA/CH, 2CH/COM)							
Power consumption	Coupler	24VDC≒, standby/run: 200mA, max. load: 400mA (coupler max. load)							
Comm. speed	100Mbps	10Mbps	100Mbps	12Mbps	10/100Mbps	500kbps	10/100Mbps	115.2kbps	
Memory ※2	Input	512 byte	256 byte	512 byte	244 byte	504 byte	255 byte	512 byte	256 byte
	Output	512 byte	256 byte	512 byte	244 byte	504 byte	255 byte	512 byte	256 byte
Max. connections for modules ※2	64 units	32 units	64 units	32 units	64 units	32 units	64 units	32 units	
Comm. connector	RJ45 connectors: 2	5-pin PCB connector	RJ45 connectors: 2	9-pin D SUB connector	RJ45 connectors: 2	5-pin PCB connector	RJ45 connectors: 2	5-pin PCB connector	
Installation method	DIN rail mounting								
Setting and monitoring	PC connection with USB 2.0 Micro type connector (comprehensive device management program, DAQMaster)								
Insulation resistance	Over 100MΩ (at 500VDC≒ megger)								
Environment	Ambient temp.	-10 to 55°C, storage: -25 to 70°C							
	Ambient humi.	35 to 85%RH, storage: 35 to 85%RH							
Protection structure	IP20 (IEC standards)								
Material	Terminal: polyamide6, Body: modified polyphenylene oxide, Base: polyamide6, polyoxymethylene								
Approval	CE, RoHS, REACH, etc.								
Weight ※3	Approx. 265g (approx. 165g)								

※1. It is for including power/special modules and excluding coupler/end modules. In case of one coupler module connecting, the ARIO digital module is available to connect up to 8 units and the ARIO analog module is available to connect up to 4 units. For connecting the modules, consider power consumption of the sensors and drivers connected the ARIO coupler.

※2. If it is over the limit size or connected units, system may be error.

※3. The weight includes packaging. The weight in parenthesis is for unit only.

※Environment resistance is rated at no freezing or condensation.

SENSORS

CONTROLLERS

MOTION DEVICES

SOFTWARE

(J) Temperature Controllers

(K) SSRs

(L) Power Controllers

(M) Counters

(N) Timers

(O) Digital Panel Meters

(P) Indicators

(Q) Converters

(R) Digital Display Units

(S) Sensor Controllers

(T) Switching Mode Power Supplies

(U) Recorders

(V) HMIs

(W) Panel PC

(X) Field Network Devices

# ARIO Series

(Unit: mm)

## Dimensions

### • Coupler

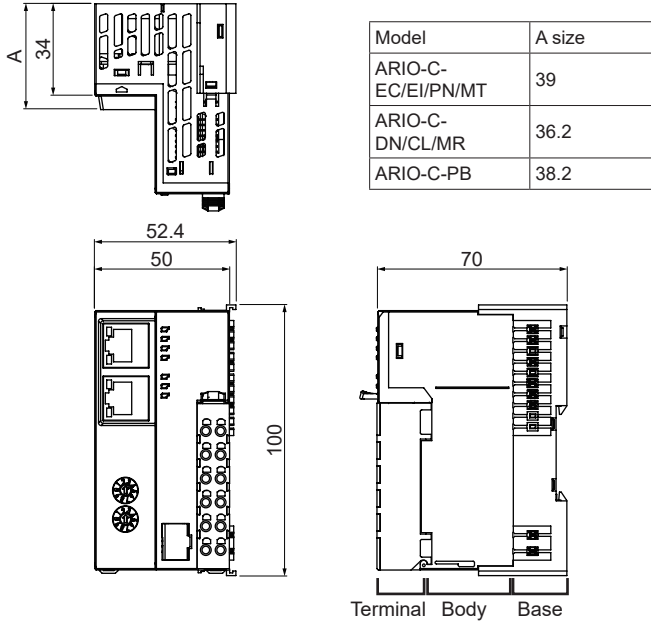

### • End module

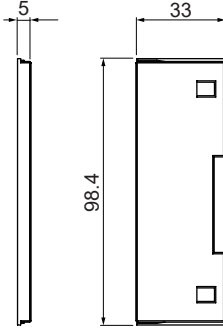

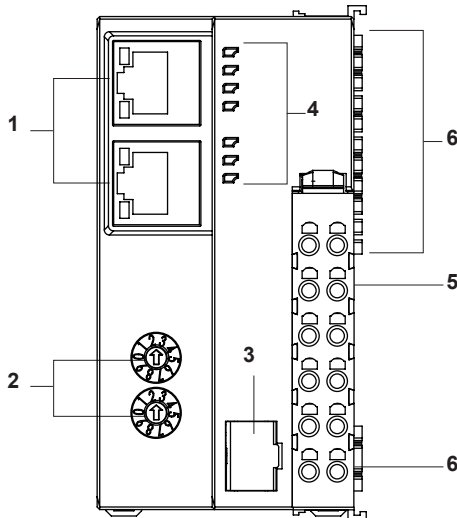

## Unit Description

※ It may be different depending on the coupler model.



### 1. Communication connector

ARIO-C-EC/PN/EI/MT	ARIO-C-PB	ARIO-C-CL/DN/MR
RJ-45: 2 	DSUB-9Pin 	5-Pin PCB connector 

### 2. Communication setting switch

ARIO-C-EC	ARIO-C-CL/DN	The others
None	Decimal rotary switches: 3 (Comm. speed, address (×10, ×1))	Hexagonal rotary switches: 2 (address (×10, ×1))

### 3. Setting connector (USB 2.0 type Micro B)



### 4. Indicators for power and comm. status

### 5. Power terminal block

### 6. ABUS comm. connector

## Digital Input/Output Module

### Specifications

Type	Digital input module		Digital output module		
Model	4CH	<b>ARIO-S-DI04N</b>	<b>ARIO-S-DI04P</b>	<b>ARIO-S-DO04N</b>	<b>ARIO-S-DO04P</b>
	8CH	<b>ARIO-S-DI08N</b>	<b>ARIO-S-DI08P</b>	<b>ARIO-S-DO08N</b>	<b>ARIO-S-DO08P</b>
I/O common	NPN		PNP	NPN	PNP
Input voltage	Turn ON: min. 7VDC= Turn OFF: max. 0.4VDC= —			—	
Output leakage voltage	—			Max. 1.2VDC= —	
I/O signal level <sup>※1</sup>	24VDC= $\pm$ 10%				
I/O current consumption	4CH	Max. 6mA/CH, 4CH/COM		—	
	8CH	Max. 6mA/CH, 8CH/COM		—	
Rated output current	4CH	—		Max. 500mA/CH, 4CH/COM	
	8CH	—		Max. 500mA/CH, 8CH/COM	
On delay time	Max. 0.5ms				
Off delay time	Max. 1.5ms				
Power consump. (ABUS)	5VDC= $\pm$ , max. 100mA (max. 0.5W)				
Installation method	DIN rail mounting				
Insulation resistance	100M $\Omega$ (at 500VDC= $\pm$ megger) I/O to inner circuit: photocoupler insulated, between CHs: non-insulated				
Environment	Ambient temp.	10 to 55°C, storage: -25 to 70°C			
	Ambient humi.	35 to 85%RH, storage: 35 to 85%RH			
Protection structure	IP20 (IEC standard)				
Material	Terminal: polyamide6, Body: modified polyphenylene oxide, Base: polyamide6, polyoxymethylene				
Approval	CE  				
Weight <sup>※2</sup>	Approx. 108g (approx. 75g)				

※1. Power supply is from I/O power of coupler or ARIO-P-F Series. Normal operation is available when I/O power voltage is supplied.

※2. The weight includes packaging. The weight in parenthesis is for unit only.

※Environment resistance is rated at no freezing or condensation.

※In case of one coupler module connecting, the ARIO digital module is available to connect up to 8 units. For connecting the modules, consider power consumption of the sensors and drivers connected the ARIO coupler.

### Dimensions

(Unit: mm)

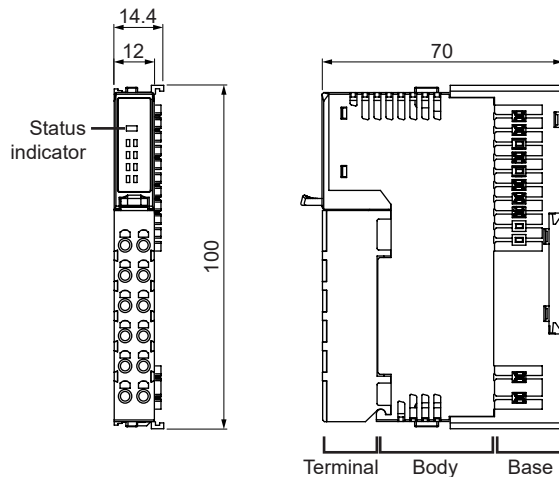

SENSORS

CONTROLLERS

MOTION DEVICES

SOFTWARE

(J) Temperature Controllers

(K) SSRs

(L) Power Controllers

(M) Counters

(N) Timers

(O) Digital Panel Meters

(P) Indicators

(Q) Converters

(R) Digital Display Units

(S) Sensor Controllers

(T) Switching Mode Power Supplies

(U) Recorders

(V) HMIs

(W) Panel PC



(X) Field Network Devices

## Analog Input/Output Module

### ■ Specifications

Type	Analog input module				
Model	2CH	<b>ARIO-S-AI02V1</b>	<b>ARIO-S-AI02V2</b>	<b>ARIO-S-AI02C1</b>	<b>ARIO-S-AI02C2</b>
	4CH	<b>ARIO-S-AI04V1</b>	<b>ARIO-S-AI04V2</b>	<b>ARIO-S-AI04C1</b>	<b>ARIO-S-AI04C2</b>
Input method	Voltage input			Current output	
Input range	-10 to 10VDC $\equiv$		0 to 10VDC $\equiv$	0 to 20mA	4 to 20mA
Accuracy	Room temp.: $\pm 0.3\%$ F.S. / Out of room temp.: $\pm 0.6\%$ F.S.				
Input impedance	Min. 1M $\Omega$ / Max. 250 $\Omega$				
Status indicator ON conditions	Below -1V or over 1V		Over 1V	Over 1mA	Over 4mA
Resolution	12bit				
Power consumption	ABUS: 5VDC $\equiv$ , max. 180mA (max. 0.9W), I/O: 24VDC $\equiv$ , max. 15mA (max. 0.36W)				

Type	Analog output module				
Model	2CH	<b>ARIO-S-AO02V1</b>	<b>ARIO-S-AO02V2</b>	<b>ARIO-S-AO02C1</b>	<b>ARIO-S-AO02C2</b>
	4CH	<b>ARIO-S-AO04V1</b>	<b>ARIO-S-AO04V2</b>	<b>ARIO-S-AO04C1</b>	<b>ARIO-S-AO04C2</b>
Output method	Voltage output			Current output	
Output range	-10 to 10VDC $\equiv$		0 to 10VDC $\equiv$	0 to 20mA	4 to 20mA
Accuracy	Room temp.: $\pm 0.3\%$ F.S. / Out of room temp.: $\pm 0.6\%$ F.S.				
Load resistance	Min. 5k $\Omega$ / Max. 350 $\Omega$				
Status indicator ON conditions	Below -1V or over 1V		Over 1V	Over 1mA	Always ON
Resolution	12bit				
Power consumption	ABUS: 5VDC $\equiv$ , max. 180mA (max. 0.9W), I/O: 24VDC $\equiv$ , max. 15mA (max. 0.36W)			ABUS: 5VDC $\equiv$ , max. 100mA (max. 0.5W), I/O: 24VDC $\equiv$ , max. 60mA (max. 1.44W)	

Installation method	DIN rail mounting				
Insulation resistance	100M $\Omega$ (at 500VDC $\equiv$ megger) I/O to inner circuit: photocoupler insulated, between channels: non-insulated				
Environment	Ambient temp.	-10 to 55°C, storage: -25 to 70°C			
	Ambient humi.	35 to 85%RH, storage: 35 to 85%RH			
Protection structure	IP20 (IEC standard)				
Material	Terminal: polyamide6, Body: modified polyphenylene oxide, Base: polyamide6, polyoxymethylene				
Approval	  				
Weight $\times 1$	Approx. 108g (approx. 75g)				

※1. The weight includes packaging. The weight in parenthesis is for unit only.

※Environment resistance is rated at no freezing or condensation.

※Power supply is from I/O power of coupler or ARIO-P-F Series. Normal operation is available when I/O power voltage is supplied. In case of one coupler module connecting, the ARIO analog module is available to connect up to 4 units. For connecting the modules, consider power consumption of the sensors and drivers connected the ARIO coupler.

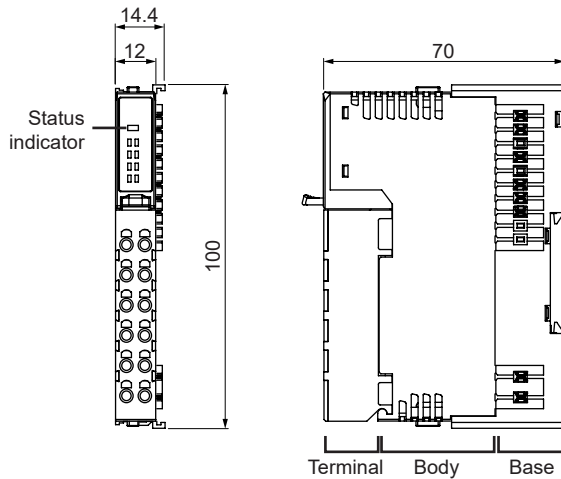

## ■ Dimensions

(Unit: mm)



## Temperature Input Module

### ■ Specifications

Type	Temperature input module		
Model	4CH	<b>ARIO-S-AI04TC</b>	<b>ARIO-S-AI04RTD</b>
Input method	Voltage input		Resistance input
Display accuracy* <sup>1</sup>	±0.2% F.S.(or ±2°C, select higher one) ±1 digit		±0.2% F.S.±1 digit
Status indicator ON conditions	Temperature input within the rated range ※ No operation when the thermometer is not attached.		
Resolution / Display	16bit / 0.1°C		
Power consumption	ABUS: 5VDC≒, max. 180mA w(max. 0.9W), I/O: 24VDC≒, max. 15mA (max. 0.36W)		
Installation method	DIN rail mounting		
Insulation resistance	100MΩ (at 500VDC≒ megger) I/O to inner circuit: photocoupler insulated, between channels: non-insulated		
Environment	Ambient temp.	-10 to 55°C, storage: -25 to 70°C	
	Ambient humi.	35 to 85%RH, storage: 35 to 85%RH	
Protection structure	IP20 (IEC standard)		
Material	Terminal: polyamide6, Body: modified polyphenylene oxide, Base: polyamide6, polyoxymethylene		
Approval	CE  		
Weight* <sup>2</sup>	Approx. 108g (approx. 75g)		

- ※1. ◎ At room temperature (23°C ± 5°C)
- Below -100°C of TC K, J, T, N, E and TC L, U, PLII: ±4°C ±1 digit
  - Below ±200°C of TC R, S: ±4°C ±1 digit
  - Below 400°C of TC B: No display accuracy
  - RTD Cu 50 Ω / 100 Ω, Ni 100 Ω / 120 Ω / 1000 Ω: ±2°C ±1digit
- ◎ Out of room temperature range
- TC: (±0.5% F.S or ±7°C, select the higher one) ± 1digit
  - RTD: (±0.5% F.S or ±3°C, select the higher one) ±1digit

※2.The weight includes packaging. The weight in parenthesis is for unit only.

※Environment resistance is rated at no freezing or condensation.

※Power supply is from I/O power of coupler or ARIO-P-F Series. Normal operation is available when I/O power voltage is supplied.

In case of one coupler module connecting, the ARIO analog module is available to connect up to 4 units. For connecting the modules, consider power consumption of the sensors and drivers connected the ARIO coupler.

SENSORS
CONTROLLERS
MOTION DEVICES
SOFTWARE

(J) Temperature Controllers
(K) SSRs
(L) Power Controllers
(M) Counters
(N) Timers
(O) Digital Panel Meters
(P) Indicators
(Q) Converters
(R) Digital Display Units
(S) Sensor Controllers
(T) Switching Mode Power Supplies
(U) Recorders
(V) HMIs
(W) Panel PC
(X) Field Network Devices

# ARIO Series

## Input type and range

Input type		Rated input range (°C)	Data display (dec)
Thermocouple (TC)	K(CA)	-200.0 to 1350.0	-2000 to 13500
	J(IC)	-200.0 to 800.0	-2000 to 8000
	E(CR)		
	T(CC)	-200.0 to 400.0	-2000 to 4000
	B(PR)	0.0 to 1800.0	0 to 18000
	R(PR)	0.0 to 1750.0	0 to 17500
	S(PR)		
	N(NN)	-200.0 to 1300.0	-2000 to 13000
	C(TT) <sup>*1</sup>	0.0 to 2300.0	0 to 23000
	G(TT) <sup>*2</sup>		
	L(IC)	-200.0 to 900.0	-2000 to 9000
	U(CC)	-200.0 to 400.0	-2000 to 4000
	Platinel II	0.0 to 1390.0	0 to 13900
	RTD	Cu 50Ω	-200.0 to 200.0
Cu 100Ω			
DPt 50Ω		-200.0 to 650.0	-2000 to 6500
DPt 100Ω			
DPt 1000Ω			
JPt 50Ω		-200.0 to 650.0	-2000 to 6500
JPt 100Ω			
JPt 1000Ω		-200.0 to 500.0	-2000 to 5000
Nickel 100Ω		-50.0 to 200.0	-500 to 2000
Nickel 120Ω			
Nickel 1000Ω			

※ 1. Same as existing W5(TT).

※ 2. Same as existing W(TT).

## Dimensions

(Unit: mm)

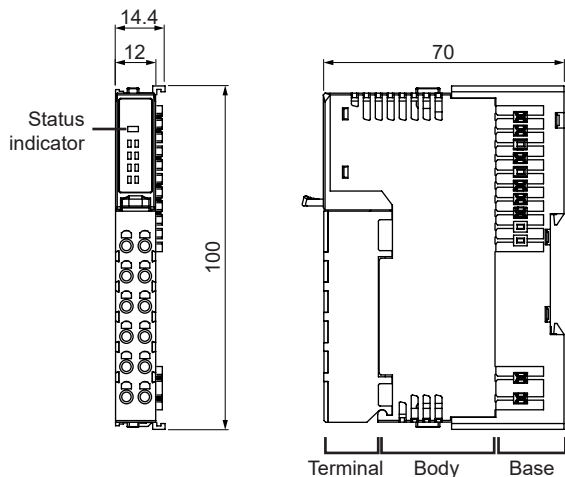

## Power Module

### ■ Specifications

#### ● Slim Remote ABUS Power Module

Model	<b>ARIO-P-B</b>	
Power supply	ABUS (external consumption)	24VDC $\pm$ , max. 320mA (max. 7.5W, max. 160mA/CH, 2CH/COM)
	ABUS (internal supply)	5VDC $\pm$ , max. 1,500mA (max. 7.5W)
Installation method	DIN rail mounting	
Insulation resistance	100M $\Omega$ (at 500VDC $\pm$ megger)	
Environment	Ambient temp.	-10 to 55°C, storage: -25 to 70°C
	Ambient humi.	35 to 85%RH, storage: 35 to 85%RH
Protection structure	IP20 (IEC standard)	
Material	Terminal: polyamide6, Body: modified polyphenylene oxide, Base: polyamide6, polyoxymethylene	
Approval	CE cULus LISTED	
Weight <sup>*1</sup>	Approx. 108g (approx. 75g)	

※The ARIO digital module is available to connect up to 8 units and the ARIO analog module is available to connect up to 4 units.

#### ● Slim Remote I/O Power Module

Model		ARIO-P-F1	ARIO-P-F2	ARIO-P-T1	ARIO-P-T2
Input	Voltage	24VDC $\pm$ 10% (max. 48W)		—	
	Max. current	Max. 2,000mA/CH, 2CH/COM		—	
Output	Voltage	24VDC $\pm$ 10% (max. 48W)		24VDC $\pm$ 10% (max. 48W)	
	Max. current	Max. 2,000mA/CH, 6CH/COM		Max. 2,000mA/CH, 8CH/COM	
No. of I/O supply power	24V	6	2	8	4
	0V	2	6	4	8
Installation method	DIN rail mounting				
Insulation resistance	100M $\Omega$ (at 500VDC $\pm$ megger)				
Environment	Ambient temp.	-10 to 55°C, storage: -25 to 70°C			
	Ambient humi.	35 to 85%RH, storage: 35 to 85%RH			
Protection structure	IP20 (IEC standard)				
Material	Terminal: polyamide6, Body: modified polyphenylene oxide, Base: polyamide6, polyoxymethylene				
Approval	CE cULus LISTED				
Weight <sup>*1</sup>	Approx. 108g (approx. 75g)				

※1. The weight includes packaging. The weight in parenthesis is for unit only.

※Environment resistance is rated at no freezing or condensation.

※For connecting the modules, consider power consumption of the sensors and drivers connected the ARIO power module.

### ■ Dimensions

(Unit: mm)

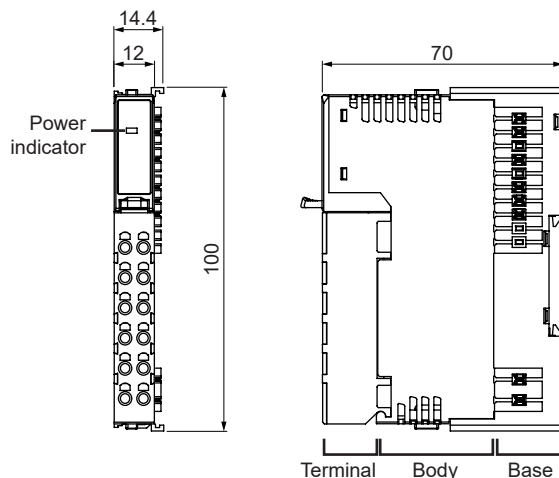

SENSORS

CONTROLLERS

MOTION DEVICES

SOFTWARE

(J) Temperature Controllers

(K) SSRs

(L) Power Controllers

(M) Counters

(N) Timers

(O) Digital Panel Meters

(P) Indicators

(Q) Converters

(R) Digital Display Units

(S) Sensor Controllers

(T) Switching Mode Power Supplies

(U) Recorders

(V) HMIs

(W) Panel PC

(X) Field Network Devices



## General Information

### Hot-swap

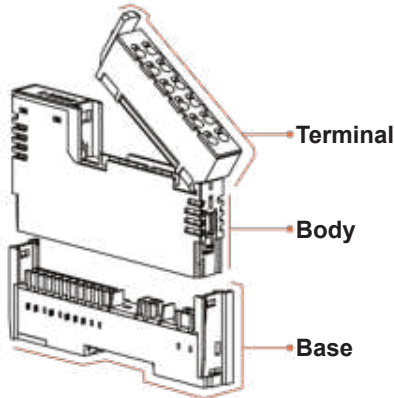

- **Terminal**  
: Part of the input and output signal comes out of the product
- **Body**  
: Part of the input and output signal controled of the product
- **Base**  
: Part of the communication (ABUS) and power connection between coupler and modules

During the operation of the system, the hardware part (terminal and body) can be replaced and maintenance and setting can be restored automatically. (All modules except coupler and end module support Hot-swap.)

- 1) Terminal / body can be replaced during operation without disassembling the terminal signal line  
: Even if the terminal / body of the abnormal I/O module is disconnected from the connected system (Coupler, I/O Module configuration), the other I/O operates normally.
- 2) Diagnostic function: Check removal or connection for terminal or body of abnormal module
- 3) Normal operation of the rearranged module even after removing the body of the module
- 4) Automatic restoration of existing settings when replacing body through backup function of internal ABUS communication

### Connecting & Removing Wires

#### Connecting

Push the wire ferrule towards direction ① to complete the connection.

#### Removing

- 1) Press and hold the groove on the terminal in direction ② with a non-conductive flat head screwdriver (tip width max. 3mm).
- 2) Pull and remove the wire towards direction ③.

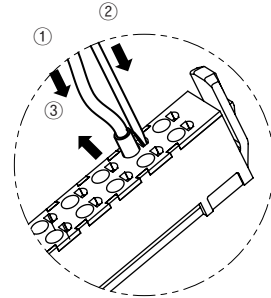

※Use the UL approved wire ferrule.

Use the copper-conductor wire with the temperature class 60°C.

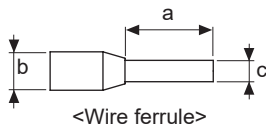

<Wire ferrule>

	a	b	c	Certified spec.
Range	8 to 12mm		0.6 to 1.3mm	AWG22-16
Recommended	10mm	Max. 3mm	1mm	AWG18

### Caution during Use

1. Follow instructions in 'Cautions during Use'. Otherwise, It may cause unexpected accidents.
2. ABUS power and I/O power should be insulated by the individually insulated power device.
3. Power supply should be insulated and limited voltage/current or Class 2, SELV power supply device.
4. Use the rated standard cables and connectors. Do not apply excessive power when connecting or disconnecting the connectors of the product.
5. Keep away from high voltage lines or power lines to prevent inductive noise. In case installing power line and input signal line closely, use line filter or varistor at power line and shielded wire at input signal line.  
For stable operation, use shield wire and ferrite core, when wiring communication wire, power wire, or signal wire.  
Do not use near the equipment which generates strong magnetic force or high frequency noise.
6. Do not touch the module communication connector part of the base.
7. Do not connect, or remove the base while connected to a power source. For removing the terminal, body or base, do not operate units for a long time without it
8. This unit may be used in the following environments.
  - ①Indoors
  - ②Altitude max. 2,000m
  - ③Pollution degree 2
  - ④Installation category II)